

KŁÓDKI WZMOCNIONE TRZPIENIOWE GERDA SECURE KSWT

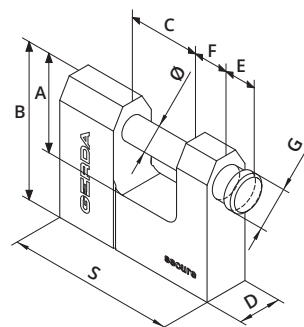

KOLOR

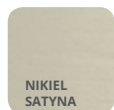









NIKIEL
SATYNA

PARAMETRY TECHNICZNE

- masywny niklowany korpus
- trzpień ze stali hartowanej, chromowany
- bębenek z mechanizmem dyskowym odporny na kurz i zabrudzenia
- hartowany pierścień zabezpieczający bębenek



GERDA CLASS

OPIS										KOD EAN	INDEKS
SECURE KSWT T50 Kłódka trzpieniowa wzmocniona, nikiel satyna, blister	50	10	22	12,5	20	18	9	12,5	12	590337300966 1	0KWT0005000.90330B